

ELECTRO-HYDRAULIC DIRECTIONAL CONTROL VALVE

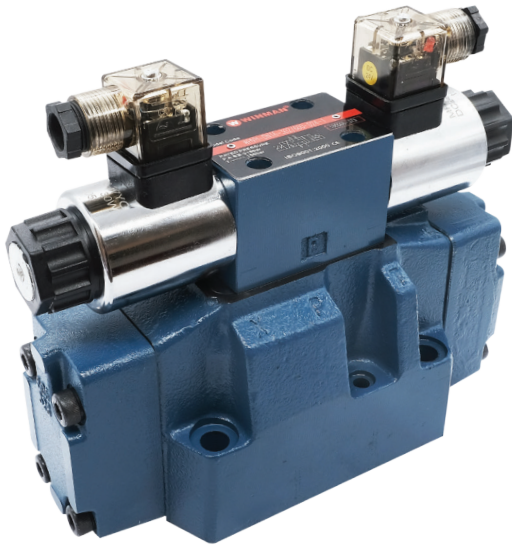

Electro-hydraulic directional control valve is a control valve which can use the pressure of the hydraulic circuit to pull the spool and change the hydraulic oil direction.

Electro-hydraulic directional control valve is the combination of the electrical operated directional control valve and the hydraulic operated directional control valve. It uses the electrical operated directional control valve to control the hydraulic operated directional control valve, and change the hydraulic oil direction.

Electro-hydraulic directional control valve and hydraulic operated directional control valve are used mostly in hydraulic systems when electrical operated directional control valve can not afford the flow. It may control the movement of the power elements, or control the direction of the flowing oil.

Technical Specification

Specification		DN10		DN16		DN25		DN32	
Model		WHVH-DN10	WHVHH-DN10	WHVH-DN16	WHVHH-DN16	WHVH-DN25	WHVHH-DN25	WHVH-DN32	WHVHH-DN32
Max. Working (Bar) pressure	P、A、B Port	280	350	280	350	280	350	280	350
	T port (internal leakage control oil)	100		100		100		100	
	Y port (external leakage control oil)	100		100		100		100	
Minimum control pressure (Bar)		10 Spring-Return 4/3 valve 4/2 valve		12 Spring-Return 4/3 valve 4/2 valve		13 Spring-Return 4/3 valve 4/2 valve		8 Spring-Return 4/3 valve 4/2 valve	
Maximum control pressure (Bar)		to250							
Max. Flow (L/min)		160		300		650		1100	
Working fluid		Mineral oil;photosphate-ester							
Fluid temp. (°C)		-20~70							
Viscosity (mm ² /s)		2.8~380							
Cleanliness		The maximum allowable cleanliness of the oil should be according to 9th degree of Standard NAS 1638. It is suggested that the minimum filter rating should be $\beta_{10} \geq 75$.							

ELECTRO-HYDRAULIC DIRECTIONAL CONTROL VALVE

Model Description

WHVH/WHVHH - * - * - * - * - * / 600 - * - * - * / * - * - * - * - * - * - *

WHVH Electro-hydraulic directional control valve
 WHVHH Hydraulic operated directional control valve

Omit : 280 bar
 H : 350 bar

DN 10
 DN 16
 DN 25
 DN 32

Main Valve return type
 Omit : Spring return
 H : Hydraulic center

Function Code
 Details as following symbol table

Serial Number - 600

Working Voltage

D12 DC 12V
 D24 DC 24V
 A110 AC 110V
 A220 AC 220V
 B110 AC 110V Rectified
 B220 AC 220V Rectified

Omit : Square Connector With Light
 Z 6 : Wire box type

Remarks

Sal material
 Omit : NBR seals
 V : FPM seals

²⁾ Omit : No reducing valve
 D3 : With reducing valve

¹⁾ Omit : Without pre-load valve
 P4.5 : with pre-load valve

Omit : Without Shifting time adjustment
 S With shifting time adjustment : Inlet flow control
 S1 Shifting time adjustment : Outlet flow control

Omit: Without Shifting time adjustment
 S With shifting time adjustment : Inlet flow control
 S1 Shifting time adjustment : Outlet flow control

Omit Without Damping
 08 : Ø0,8 Damping
 10 : Ø1,0 Damping
 12 : Ø1,2 Damping











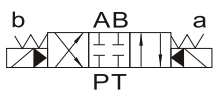
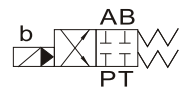
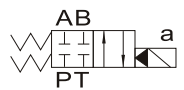
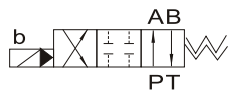
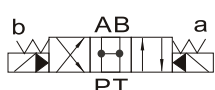
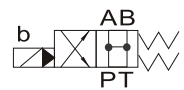
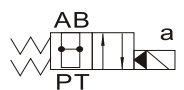
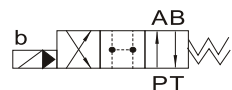
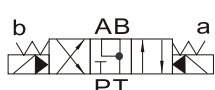

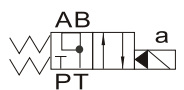
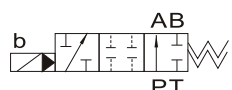

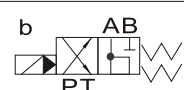

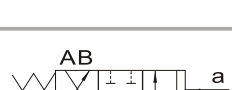
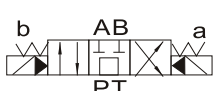
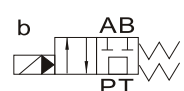
I : Intl Cntr Intl disch
 XY : Extl Cntr Extl disch
 X : Extl Cntr Intl disch
 Y : Intl Cntr Extl disch

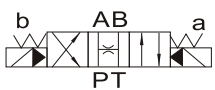
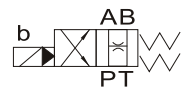
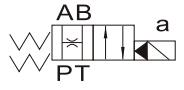
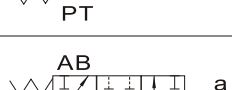
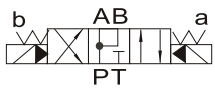
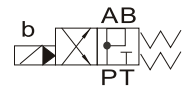
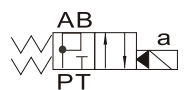
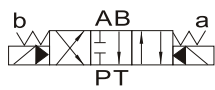
Explanation

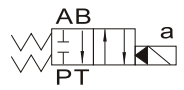
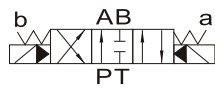
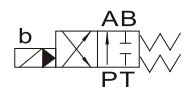
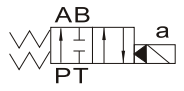
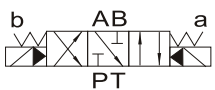
- For neutral unloaded directional control valve it must be ordered seperately. There is no model (WHVH DN10) Electro-hydraulic directional control valve NS10.
- Only applied when the controlling pressure is higher than 250 Bar

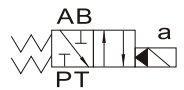
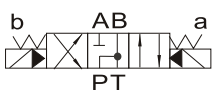
ELECTRO-HYDRAULIC DIRECTIONAL CONTROL VALVE
Code Symbol

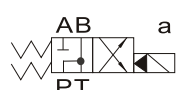
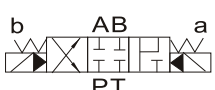
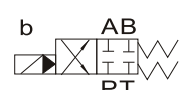
Spring return

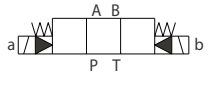
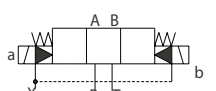
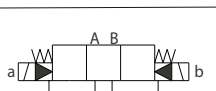
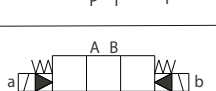
302		2828		2828L		282	
303		2838		2838L		283	
304		2848		2848L		288	
305		2858		2858L		282L	
306		2868		2868L		283L	
307		2878		2878L		288L	
309		2898		2898L			
3010		28108		28108L			
3011		28118		28118L			
3012		28128		28128L			
3025		28288		28258L			
3029		28298		28298L			
						WHVH...	
						WHVH... X/...	
						WHVH... Y/...	
						WHVH... XY/...	

ELECTRO-HYDRAULIC DIRECTIONAL CONTROL VALVE

Name Of Solenoid

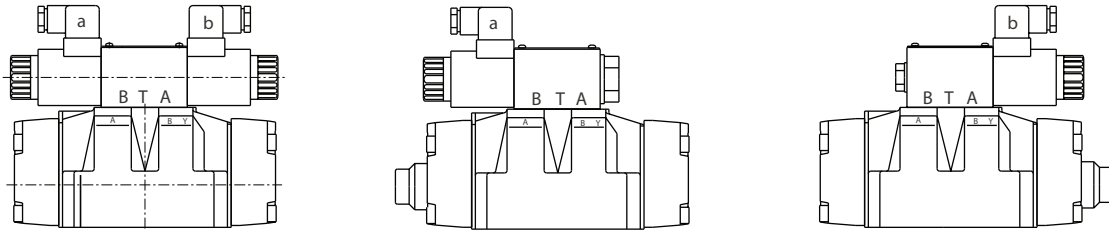

1. a When movement a, P→A B→T
2. b When movement b, P→B A→T
3. 306 Oil flow in the opposite direction with the above-mentioned movement.
For 3029, when solenoid "a" works, P→A

DN10 Specification Performance curve (Measured at $v=41\text{mm}^2/\text{s}$ and $t=50^\circ\text{C}$)

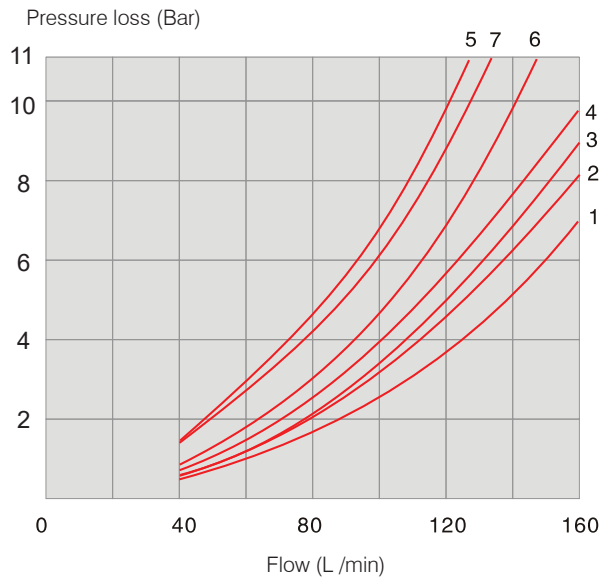

Function	Switching position			
	P→A	P→B	A→T	B→T
302	1	2	4	5
305	1	4	1	1
306	4	2	2	6
303	4	4	1	4
304	1	2	1	3
3012	2	3	1	4
309	4	4	3	4
3025	4	1	3	4
3029	2	3	3	5
3010	3	3	3	4
307	2	2	3	5

Function	Neutral		
	A→T	B→T	P→T
305	3	-	6
306	-	-	7
303	1	3	5
3025	-	7	5

Function	Neutral		
	A→T	B→T	P→T
3012	3	-	-
3010	-	4	-

ELECTRO-HYDRAULIC DIRECTIONAL CONTROL VALVE

DN16 Specification Performance Curve (Measured at $v = 41 \text{ mm}^2/\text{s}$ and $t = 50^\circ\text{C}$)

302

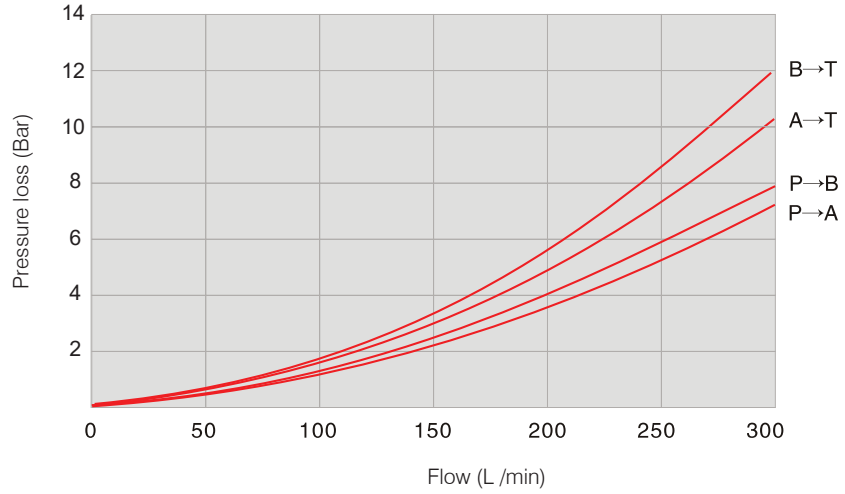

306

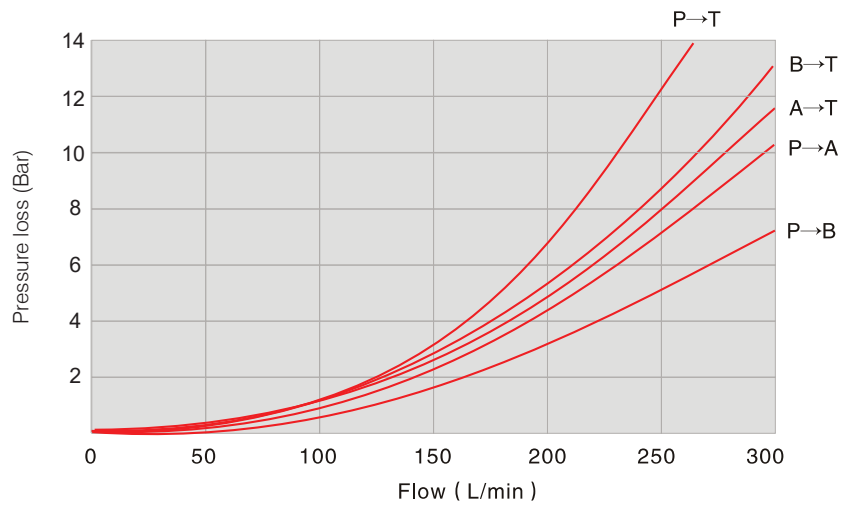

3029

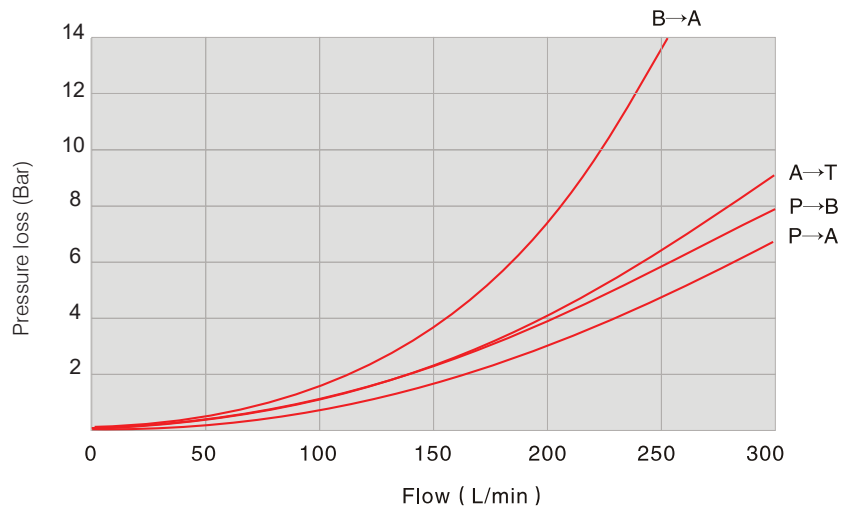

ELECTRO-HYDRAULIC DIRECTIONAL CONTROL VALVE

DN25 Specification Performance (Measured at $v=41\text{mm}^2/\text{s}$ and $t=50^\circ\text{C}$)

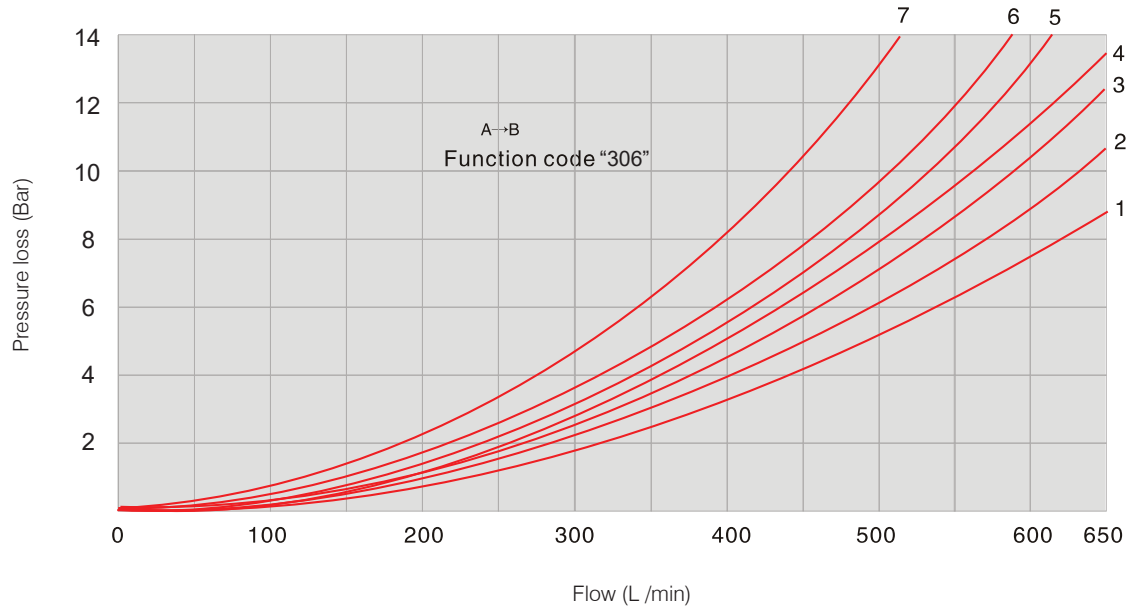

Function	Switching position			
	P→A	P→B	A→T	B→T
302	1	1	1	3
305	1	4	3	3
306	3	1	2	4
303	4	4	3	4
304	2	2	3	5
3012	2	2	3	3
309	4	4	1	4
3025	4	1	1	5
3029	2	1	1	-
3010	2	1	1	6
307	4	4	3	6

7. Function code "306" type, neutral position P→T
 8. Function code "3029" type, control position A→B

ELECTRO-HYDRAULIC DIRECTIONALLY CONTROL VALVE

DN32 Specification Performance Curve (Measured at $v=41\text{mm}^2/\text{s}$ and $t=50^\circ\text{C}$)

302, 304, 3029

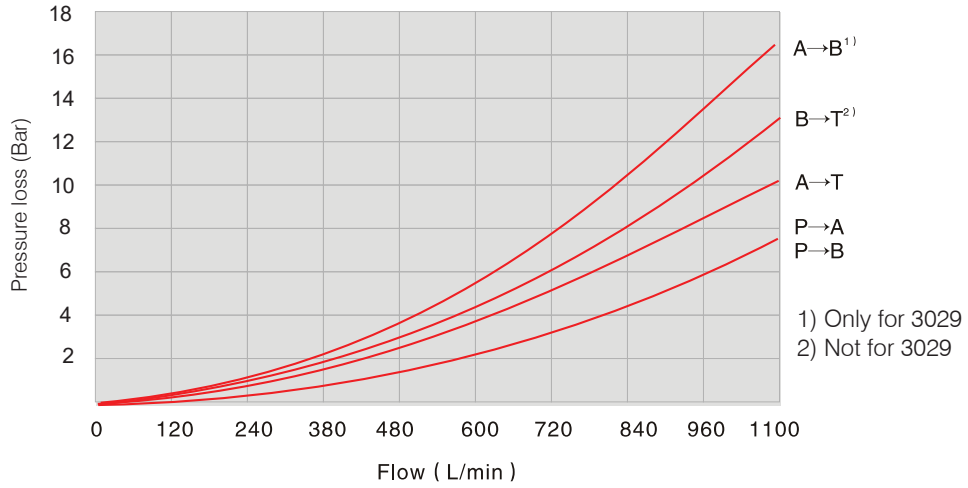

306

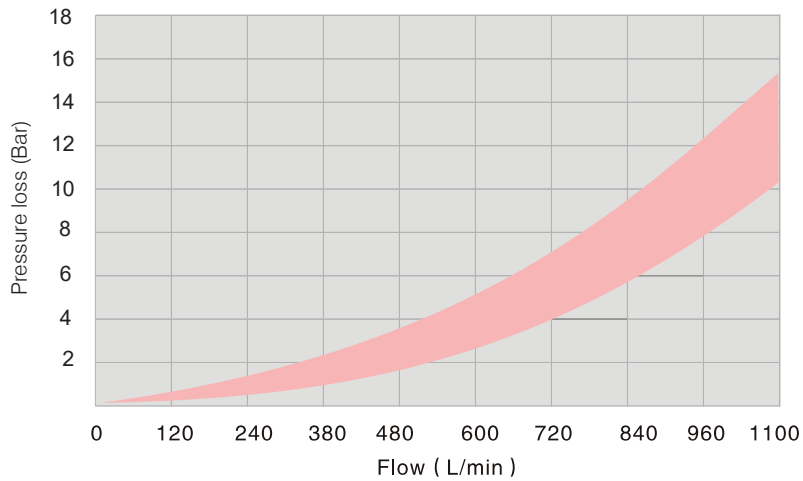
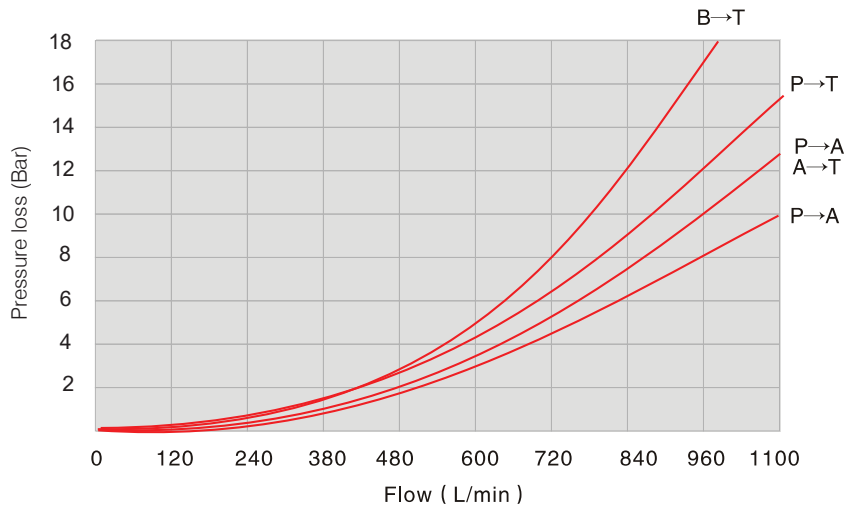

ELECTRO-HYDRAULIC DIRECTIONAL CONTROL VALVE

External Dimensions (DN10 Direct Current Plug Type)

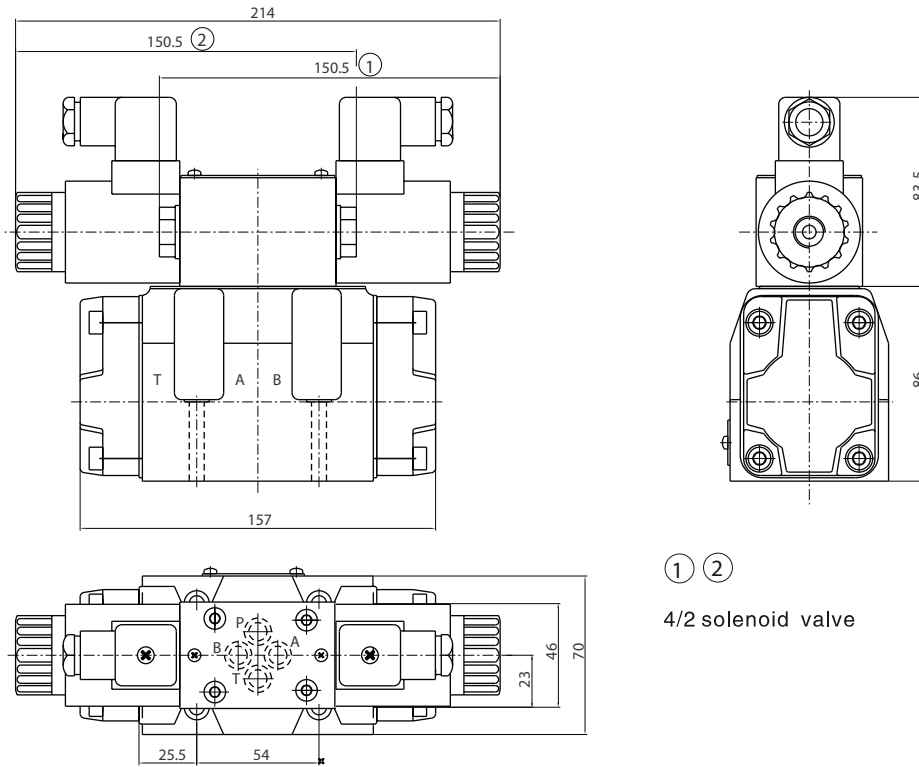

External Dimensions (DN10 Direct current wire box type)

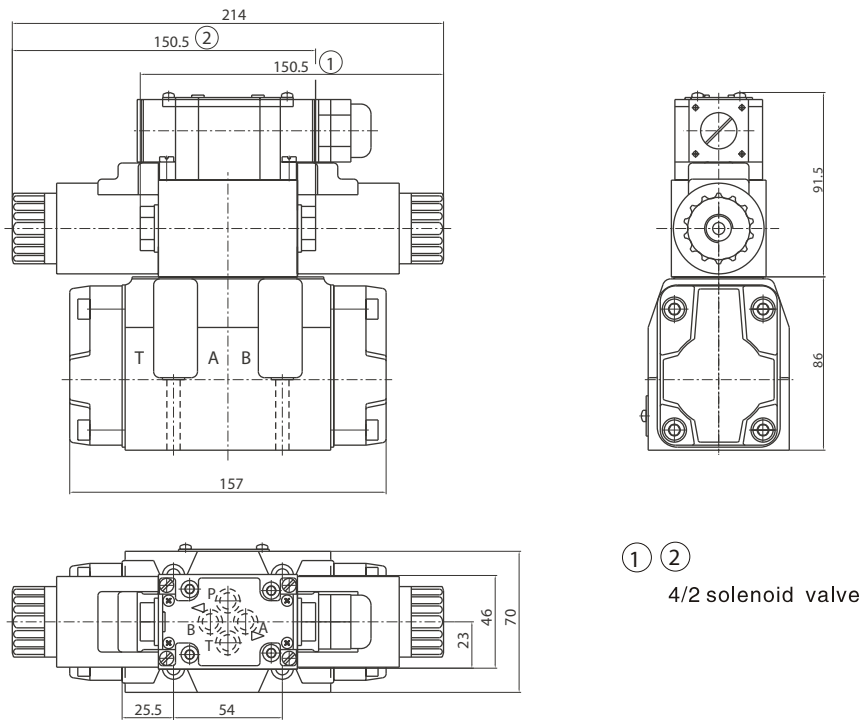

ELECTRO-HYDRAULLIC DIRECTIONAL CONTROL VALVE

External Dimensions (DN10 Alternating Current Type)

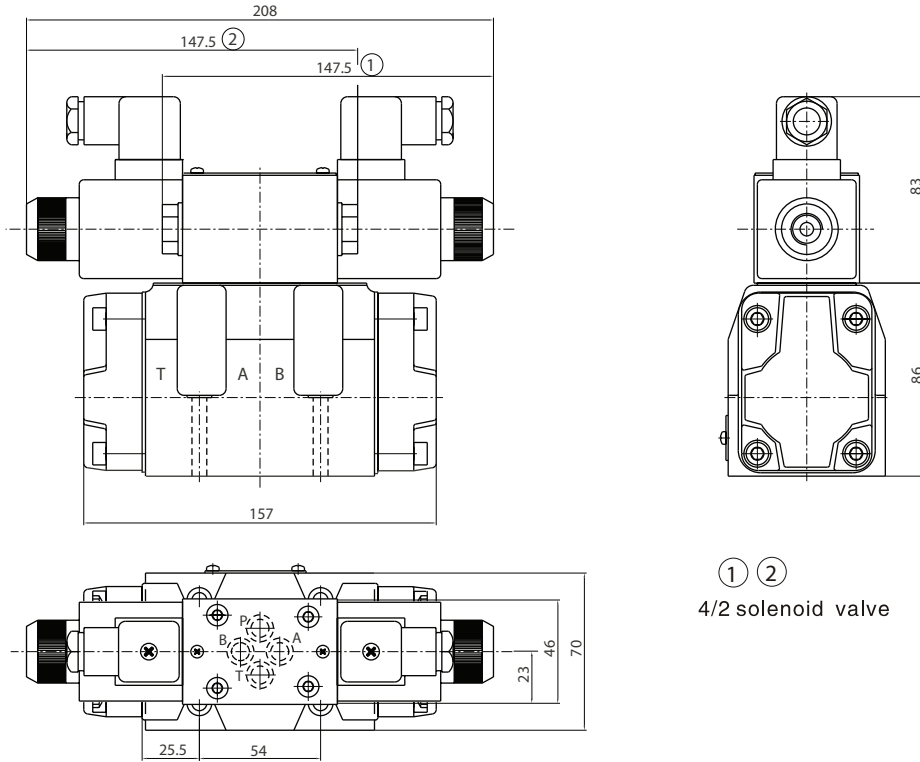

External Dimensions (DN10 Alternating Current Wire Box Type)

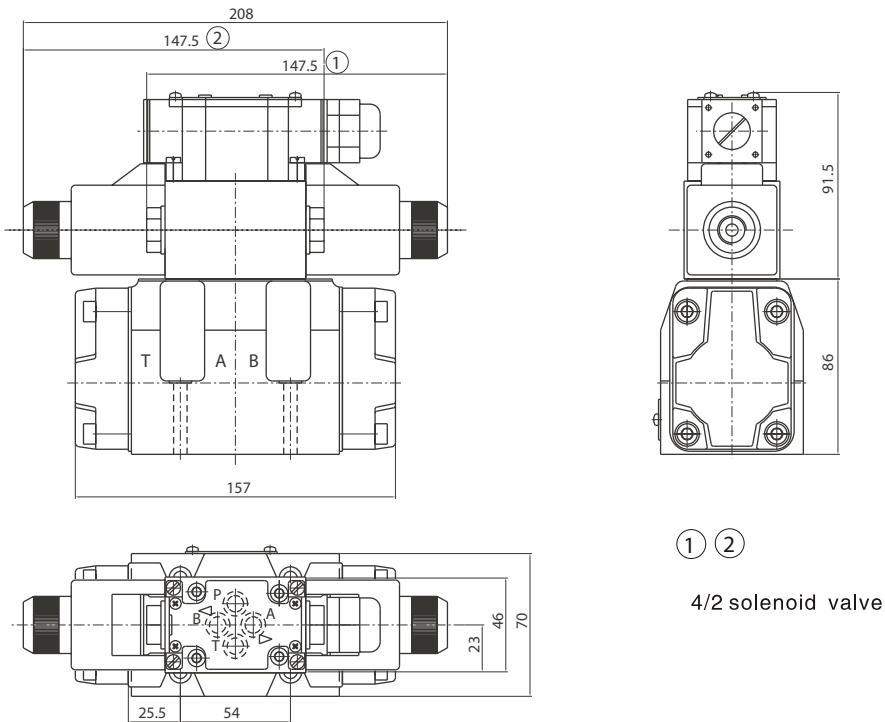

ELECTRO-HYDRAULIC DIRECTIONAL CONTROL VALVE

DN10 Size Of Subplate Oil Port

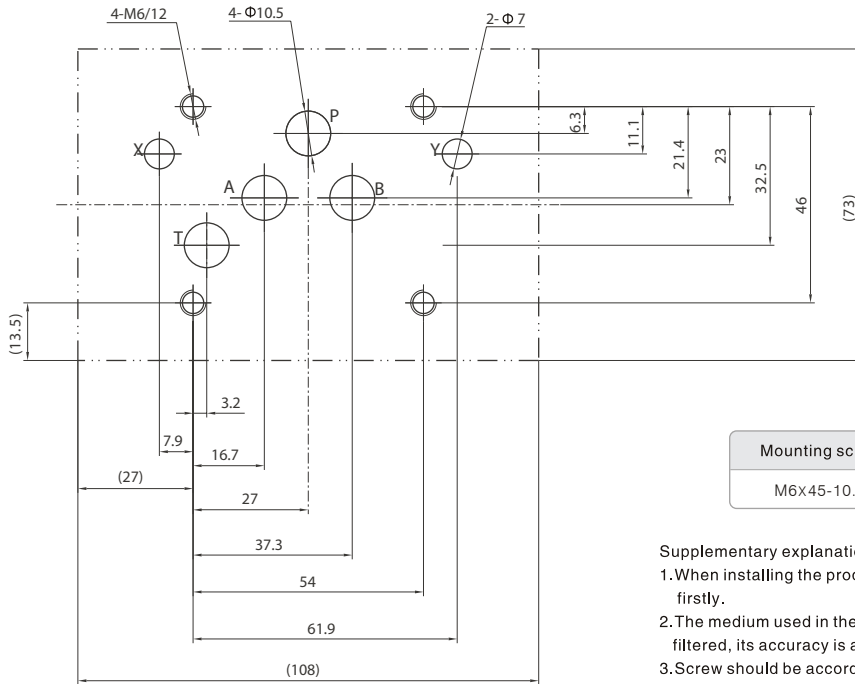

Mounting screw	Amount	Tighten torque
M6X45-10.9	4	15Nm

Supplementary explanation

1. When installing the product, considering horizontal position firstly.
2. The medium used in the hydraulic system must be filtered, its accuracy is at least 20 μ m.
3. Screw should be according to the parameters in catalogue.
4. The surface, connecting with the valve, should be Ra0.8 roughness, and 0.01/100mm flatness.

External Dimensions (DN16 Alternating Current Wire Box Type)

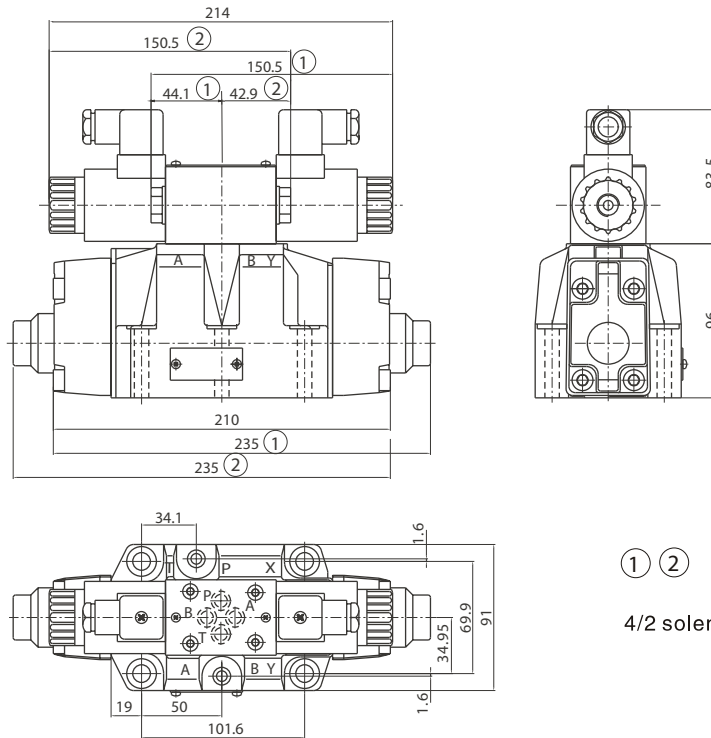

① ②

4/2 solenoid valve

ELECTRO-HYDRAULIC DIRECTIONAL CONTROL VALVE

External Dimensions (DN16 Direction Current Wire Box Type)

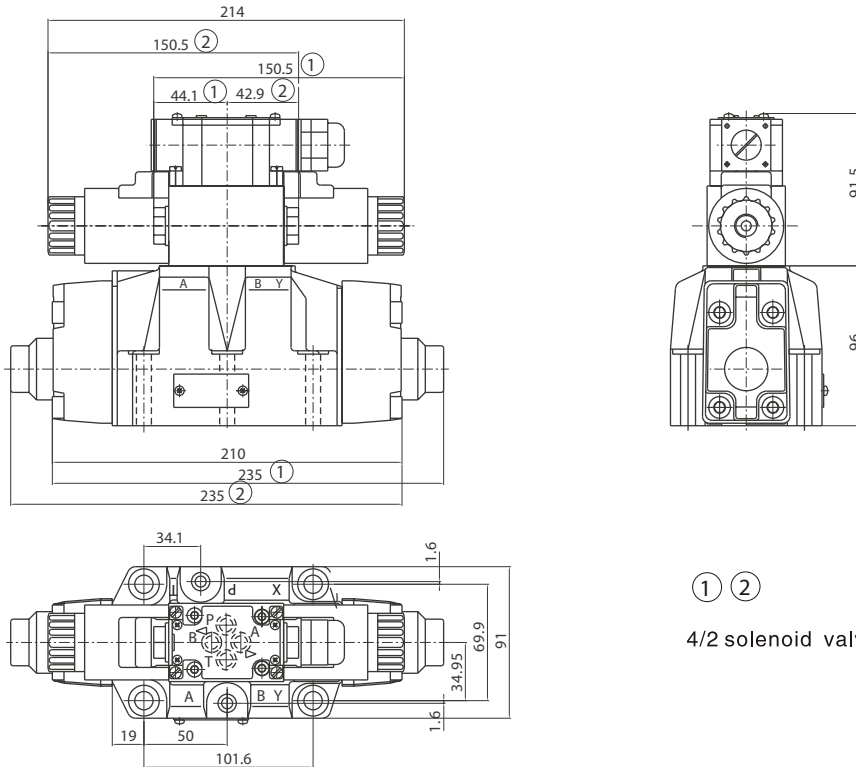

External Dimensions (DN16 Alternating Current Wire Box Type)

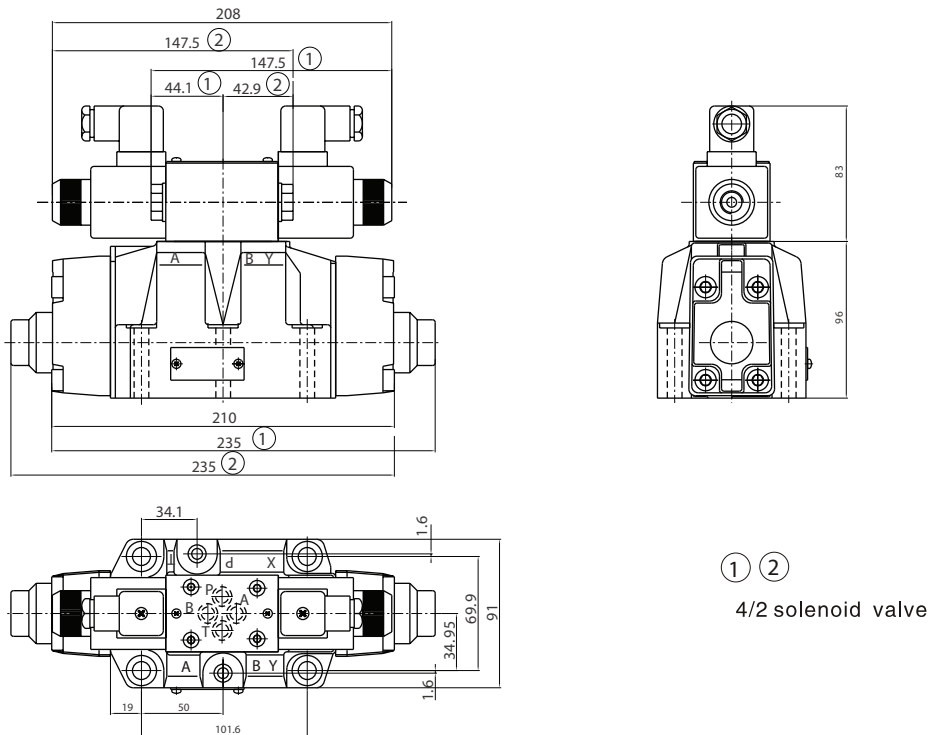

ELECTRO-HYDRAULIC DIRECTIONAL CONTROL VALVE

External Dimensions (DN16 Alternating Current Wire Box Type)

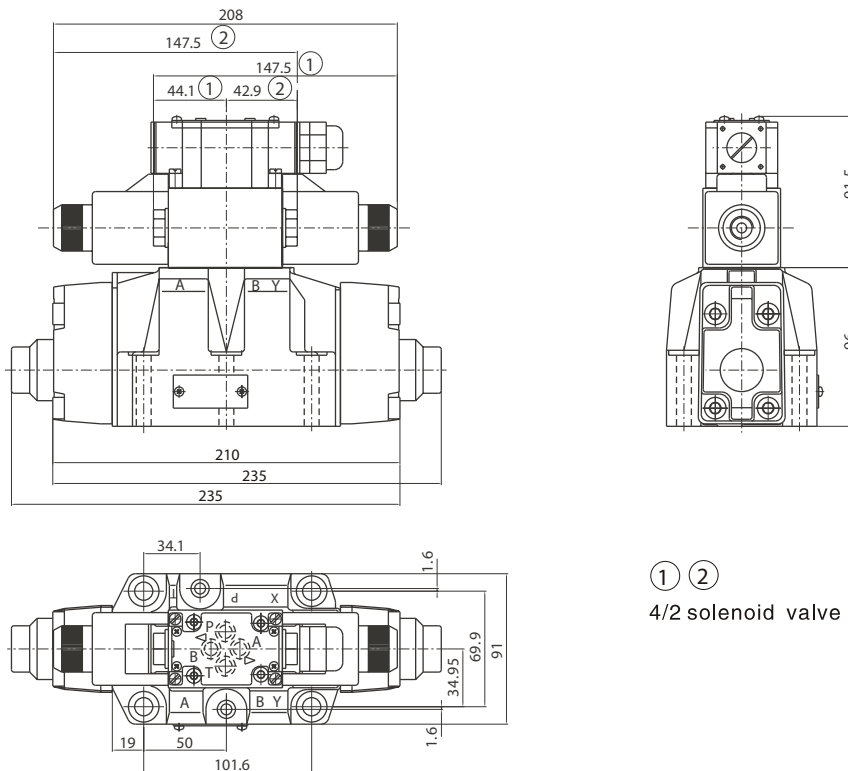

① ②
 4/2 solenoid valve

DN16 Size Of Subplate Oil Port

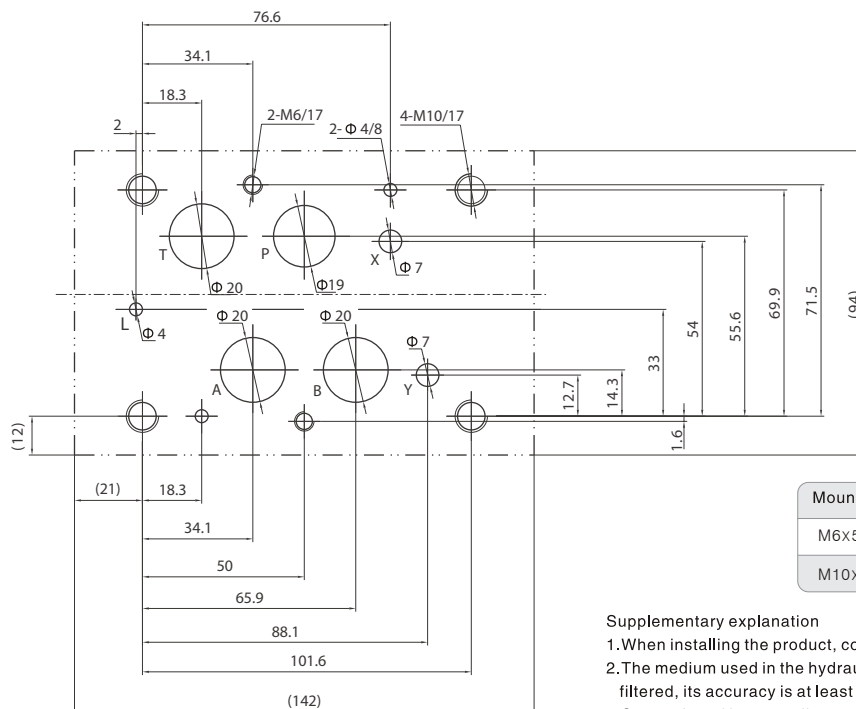

Mounting screw	Amount	Tighten torque
M6x55-10.9	2	15Nm
M10x60-10.9	4	75Nm

Supplementary explanation

1. When installing the product, considering horizontal position firstly.
2. The medium used in the hydraulic system must be filtered, its accuracy is at least $20 \mu\text{m}$.
3. Screw should be according to the parameters in catalogue.
4. The surface, connecting with the valve, should be $\text{Ra}0.8$ roughness, and $0.01/100\text{mm}$ flatness.

ELECTRO-HYDRAULIC DIRECTIONAL CONTROL VALVE

External Dimensions (DN25 Direct Current Plug Type)

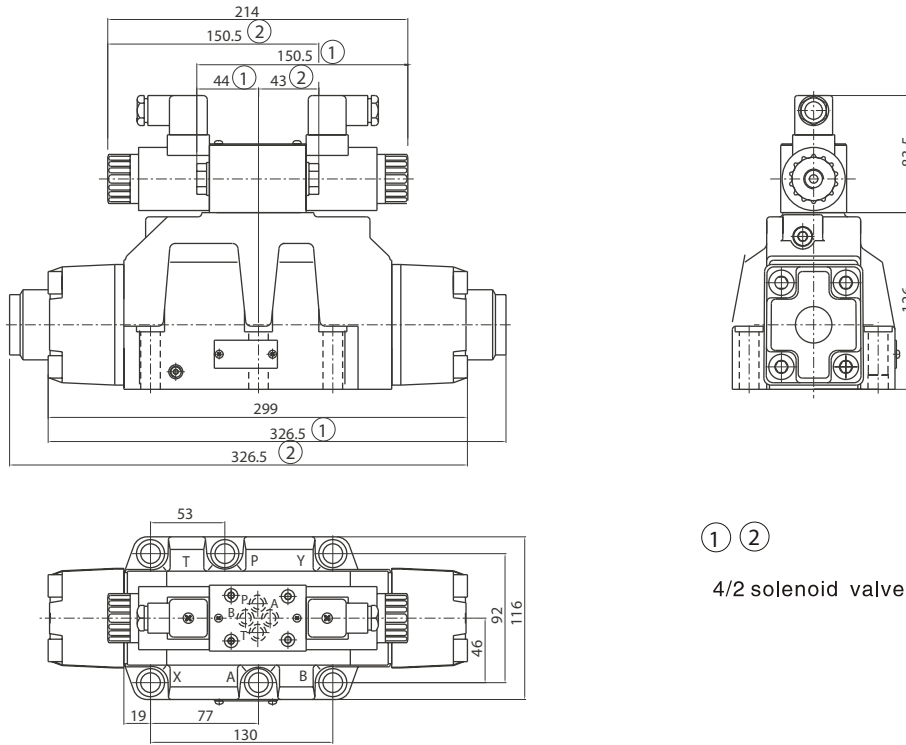

External Dimensions (DN25 Direct Current Wire Box Type)

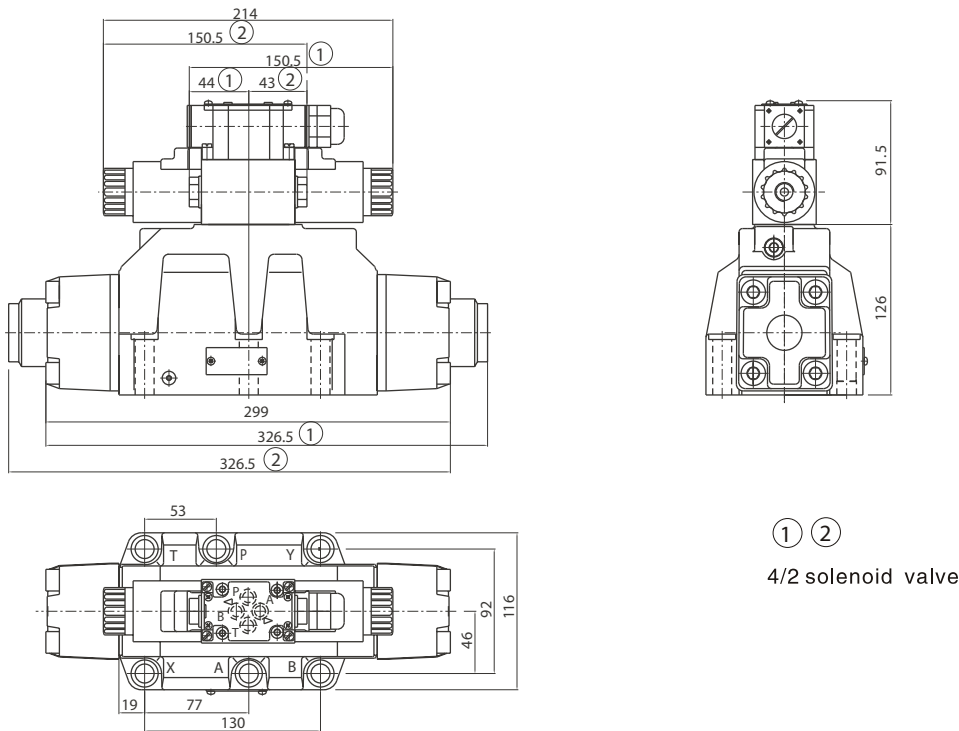

Electro-hydraulic directional control valve

External Dimensions (DN25 Alternating Current Plug Type)

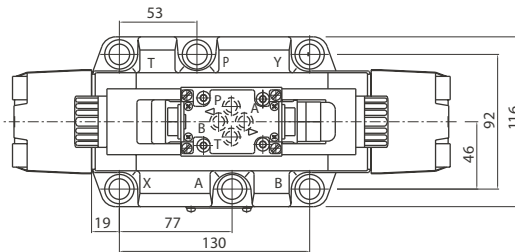
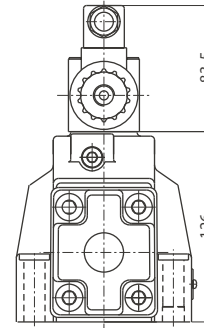
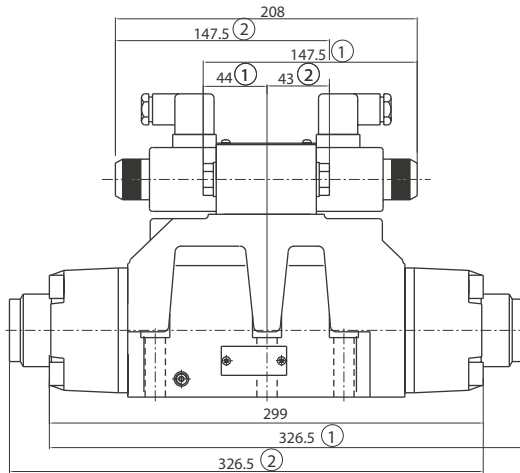

① ②

4/2 solenoid valve

External Dimensions (DN25 Alternating Current Wire Box Type)

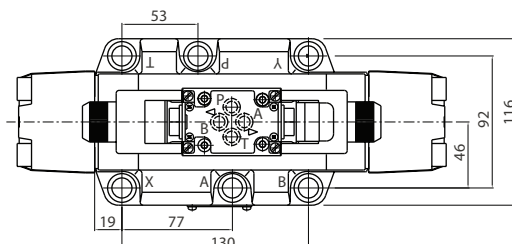
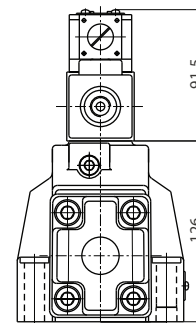
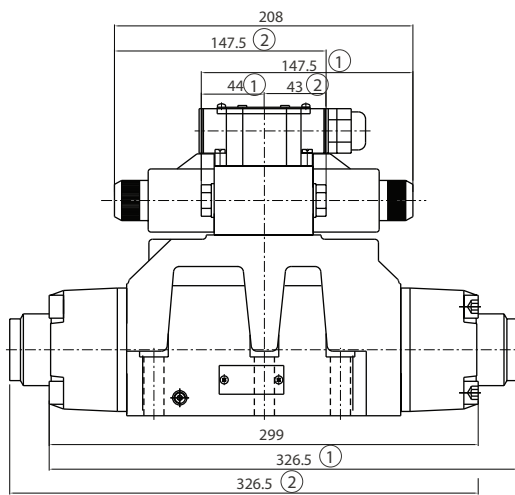

① ②

4/2 solenoid valve

ELECTRO-HYDRAULIC DIRECTIONAL CONTROL VALVE

External Dimensions (DN32 Direct Current Wire Box Type)

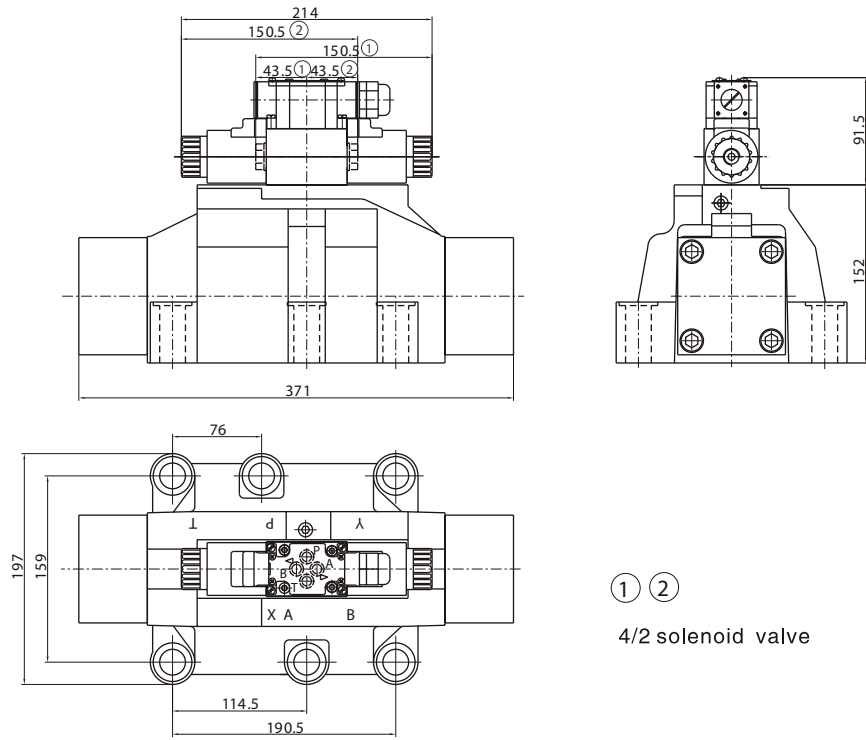

External Dimensions (DN32 Alternating Current Plug Type)

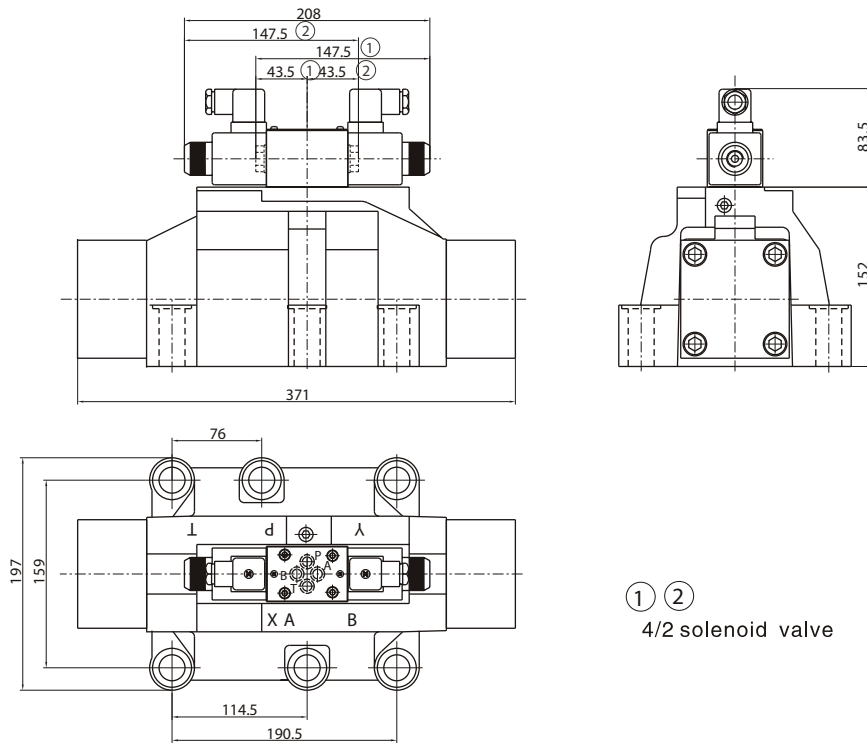

ELECTRO-HYDRAULIC DIRECTIONAL CONTROL VALVE

External Dimensions (DN32 Alternating Current Wire Box Type)

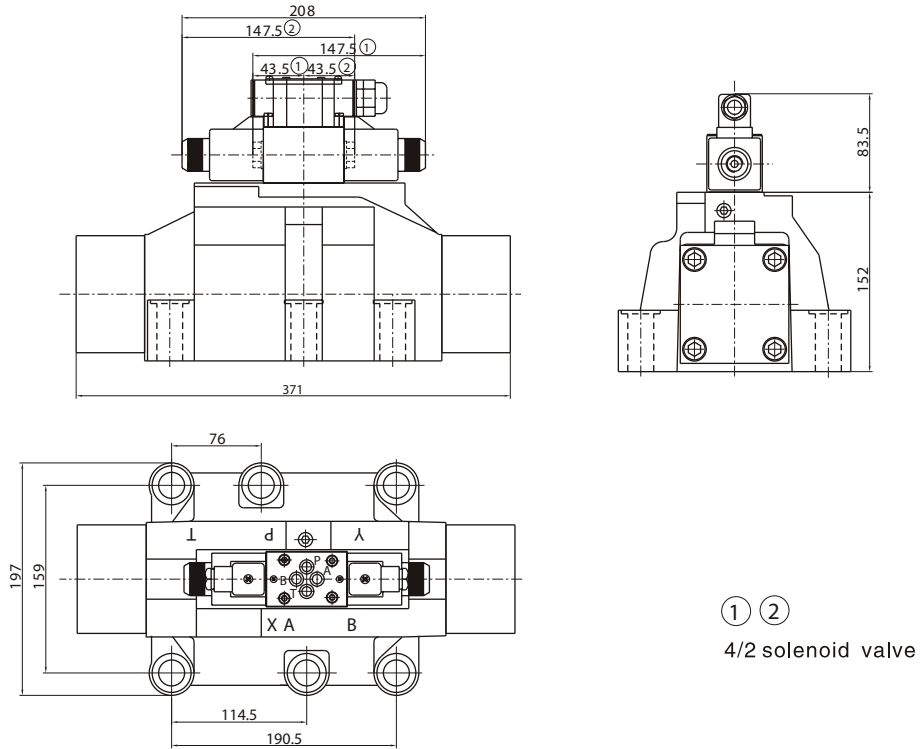

10 Size Of Subplate Oil Port

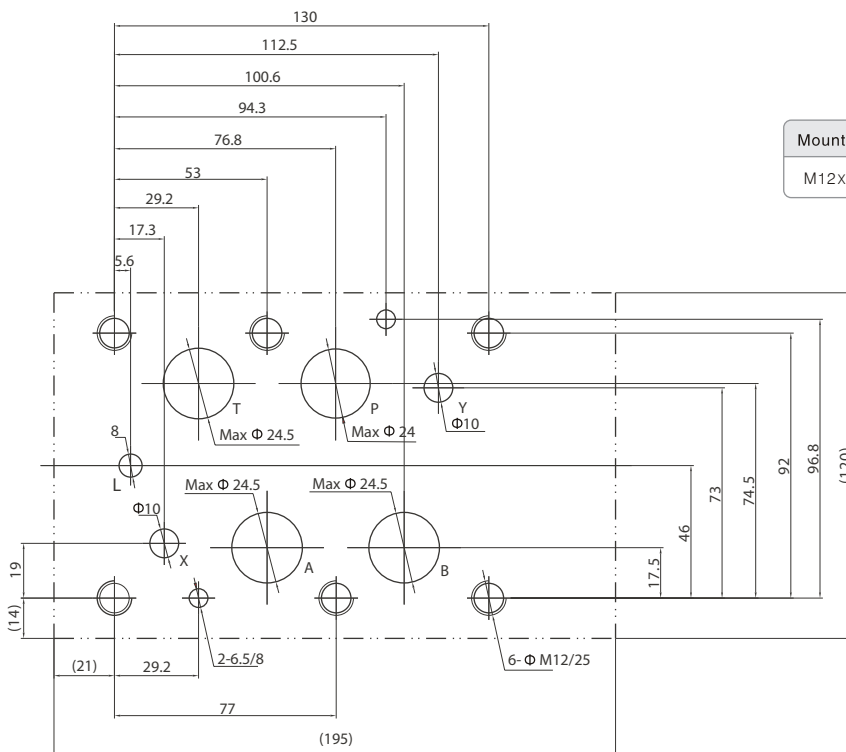

Mounting screw	Amount	Tighten torque
M12x60-10.9	6	130Nm

Supplementary explanation

1. When installing the product, considering horizontal position firstly.
2. The medium used in the hydraulic system must be filtered, its accuracy is at least $20 \mu m$.
3. Screw should be according to the parameters in catalogue.
4. The surface, connecting with the valve, should be Ra0.8 roughness, and 0.01/100mm flatness.